

Smartgen®

HGM6100U Series Automatic Control Controllers (HGM6110U/6110UC/6120U/6120UC)

USER MANUAL



Smartgen Technology



众智电子 Chinese trademark

Smartgen[®] English trademark

Smartgen — make your generator *smart*

Smartgen Technology Co., Ltd

No. 28 Jinsuo Road

Zhengzhou

Henan Province

P. R. China

Tel: +86-371-67988888

+86-371-67981888

+86-371-67991553

+86-371-67992951/67992952

+86-371-67981000(overseas)

Fax: 0086-371-67992952

Web: <http://www.smartgen.com.cn>

<http://www.smartgen.cn>

Email: sales@smartgen.com.cn

All rights reserved. No part of this publication may be reproduced in any material form (including photocopying or storing in any medium by electronic means or other) without the written permission of the copyright holder.

Smartgen Technology reserves the right to change the contents of this document without prior notice.

Software Version

Date	Version	Content
2011-09-15	1.0	Original release
2012-06-04	1.1	Some parameters are optimized.
2014-10-28	1.2	Modify the foil color.

Contents

1	SUMMARY	4
2	PERFORMANCE AND CHARACTERISTICS	5
3	SPECIFICATION	7
4	OPERATION.....	8
4.1	KEYS DSCRIPTION.....	8
4.2	CONTROLLER PANEL	9
4.3	AUTOMATIC START/STOP OPERATION.....	10
4.4	MANUAL START/STOP OPERATION.....	12
5	PROTECTION	13
5.1	WARNINGS.....	13
5.2	SHUTDOWN ALARMS.....	15
6	CONNECTIONS	17
7	PARAMETER RANGE AND DEFINITION.....	19
7.1	PARAMETER CONTENT AND RANGE TABLE (TABLE 1).....	20
7.2	PROGRAMMABLE OUTPUT 1-4 TABLE (TABLE 2)	26
7.3	PROGRAMMABLE INPUT 1-5 TABLE (ALL IS ACTIVE WHEN CONNECT TO GROUND (B-) (TABLE 3)	27
7.4	SENSOR SELECTION (TABLE 4)	28
7.5	CONDITIONS OF CRANK DISCONNECT (TABLE 5)	29
8	PARAMETER SETTING	30
9	SENSOR SETTING	32
10	COMMISSIONING.....	33
11	TYPICAL APPLICATION.....	34
12	INSTALLATION.....	36
12.1	FIXING CLIPS.....	36
12.2	OVERALL DIMENSION AND PANEL CUTOUT	37
13	FAULT FINDING	39

1 SUMMARY

HGM6100U series automatic controller, integrating digital, intelligent and network techniques, is used for automatic control and monitoring system of genset. It can carry out functions of automatic start/stop, data measurement, alarm protection and three “remote” (remote control, remote measure and remote communication). The controller uses LCD display, optional display interface including Chinese, English, Spanish and Russian with easy and reliable operation.

HGM6100U series automatic controller uses micro-processing technique which can achieve precision measurement, value adjustment, timing and threshold setting etc.. All the parameters can be configured from front panel or use programmable interface (or RS485 interface) to adjust via PC. It can be widely used in all types of automatic control system for its compact structure, simple connections and high reliability.

2 PERFORMANCE AND CHARACTERISTICS

HGM6100U controller has four variants:

HGM6110U/6110UC: Automatic Start Module, it controls generator to start/stop by remote start signal;

HGM6120U/6120UC: Based on **HGM6110U/6110UC**, it adds mains AC monitoring and mains/generator automatic switching control (AMF), especially suitable for the automation system composed by mains and genset.

Note1: **HGM6110UC/6120UC** has RS485 port, **HGM6110U/6120U** without.

Note2: **HGM6110UC/6120UC** is taken as an example to describe in this manual.

- 132*64 LCD display with backlight, optional language interface (Chinese, English, Spanish and Russian), push-button operation;
- Acrylic screen, improved wearable and scratch resistance property;
- Silica-gel panel and keys can well adapt to higher and lower temperature;
- With RS485 communication port, can achieve “three remote” functions via MODBUS protocol;
- Adapt to 3P4W, 3P3W, 1P2W and 2P3W (120V/240V), 50Hz/60Hz AC power system;
- Can measure and display 3 phase voltage, 3 phase current, frequency, power parameter of mains/gens;

Mains

Line voltage (Uab, Ubc, and Uca)

Phase voltage (Ua, Ub, and Uc)

Frequency HZ

Generator

Line voltage (Uab, Ubc, and Uca)

Phase voltage (Ua, Ub, and Uc)

Frequency HZ

Load

Current IA, IB, IC

Active power KW

Reactive power KVar

Apparent power KVA

Power factor PF

Generator accumulated energy kWh

- Mains have functions of over/under voltage and lack of phase; Gens have functions of over/under voltage, over/under frequency and over current;
- Precision measure and display of parameters about engine,

Temp. (WT),	°C/ °F both are displayed
Oil pressure (OP),	kPa/Psi/Bar are all displayed
Fuel level (FL),	%
Speed (SPD),	RPM
Battery Voltage (VB),	V
Charger Voltage (VD),	V

Hours counter (HC) can accumulate Max. 999999 hours.

Start times can accumulate Max.999999 times.











- Control protection: Automatic start/stop of genset, load transfer(ATS control) and perfect failure display and protection;
- With ETS, idle speed control, pre-heat control, speed droop/raising control, all of them are relay output;
- Parameter setting: Allow user to modify setting and store them in internal FLASH memory. The parameters cannot be lost even when power off. All of parameters can be set not only from the front panel, but also use programmable interface (or PS485 interface) to adjust them via PC.;
- Multi sensors of temperature, pressure and fuel level can be used directly, parameters can be defined by user;
- Multi conditions of crank disconnect (speed sensor, oil pressure, generator) can be selected;
- Power supply range: (8~35)VDC, accommodating to different starting battery volts;
- All parameters use digital modulation, instead of analog modulation using conventional potentiometer, having improved reliability and stability;
- Add rubber gasket between shell and controller screen, the waterproof can reach IP55;
- Controller is fixed by metal fixing clips;
- Modular design, flame-retardant ABS shell, embedded mounting, compact structure and easy installation.

3 SPECIFICATION

Items	Contents
Working Voltage	DC8.0V to DC35.0V, continuous
Power Consumption	<3W(Standby mode: ≤2W)
AC System 3P4W 3P3W 1P2W 2P3W	AC15V - AC360 V (ph-N) AC30V - AC620 V (ph-ph) AC15V - AC360 V (ph-N) AC15V - AC360 V (ph-N)
AC Alternator Frequency	50Hz/60Hz
Rotate speed sensor Voltage	1.0V to 24V (RMS)
Rotate speed sensor Frequency	10,000 Hz (max.)
Start Relay Output	16 A DC28V at supply voltage
Fuel Relay Output	16 A DC28V at supply voltage
Programmable Relay Output 1	7 A DC28V at supply voltage
Programmable Relay Output 2	7 A 250VAC volt-free output
Programmable Relay Output 3	16 Amp 250VAC volt-free output
Programmable Relay Output 4	16 A 250VAC volt-free output
Overall Dimensions	197 mm x 152 mm x 47mm
Panel Cutout	186mm x 141mm
C.T. Secondary Current	5A (rated)
Working Condition	Temperature: (-25~70)°C; Humidity: (20~93)%
Storage Condition	Temperature: (-25~+70)°C
Protection Level	IP55 Gasket
Insulation Intensity	Apply AC2.2kV voltage between high voltage terminal and low voltage terminal; The leakage current is not more than 3mA within 1min.
Weight	0.56kg

4 OPERATION

4.1 KEYS DSCRIPTION

	Stop/ Reset	Can stop generator under Manual/Auto mode; Can reset shutdown alarm; Press this key at least 3 seconds to test panel indicators are OK or not(lamp test); During stopping process, press this key again can stop generator immediately.
	Start	Start genset under Manual or Manual Test mode.
	Manual	Pressing this key will set the module as Manual mode.
	Auto	Pressing this key will set the module as Auto mode.
	Running with load	Controller is under manual testing mode. Under this mode, gen-set will run automatically with load when gens normal. (HGM6110UC without)
	Gens Close/Open	Can control gens to switch on or off in Manual mode.
	Set/ Confirm	Shift cursor to confirm In parameters setting menu.
	Up/Increase	Screen scroll; Up cursor and increase value in setting menu.
	Down/Decrease	Scroll screen; Down cursor and decrease value in setting menu.
	Menu	Pressing this key will set menu; Again pressing this key can return main interface.

4.2 CONTROLLER PANEL

HGM6110UC Panel Indicators

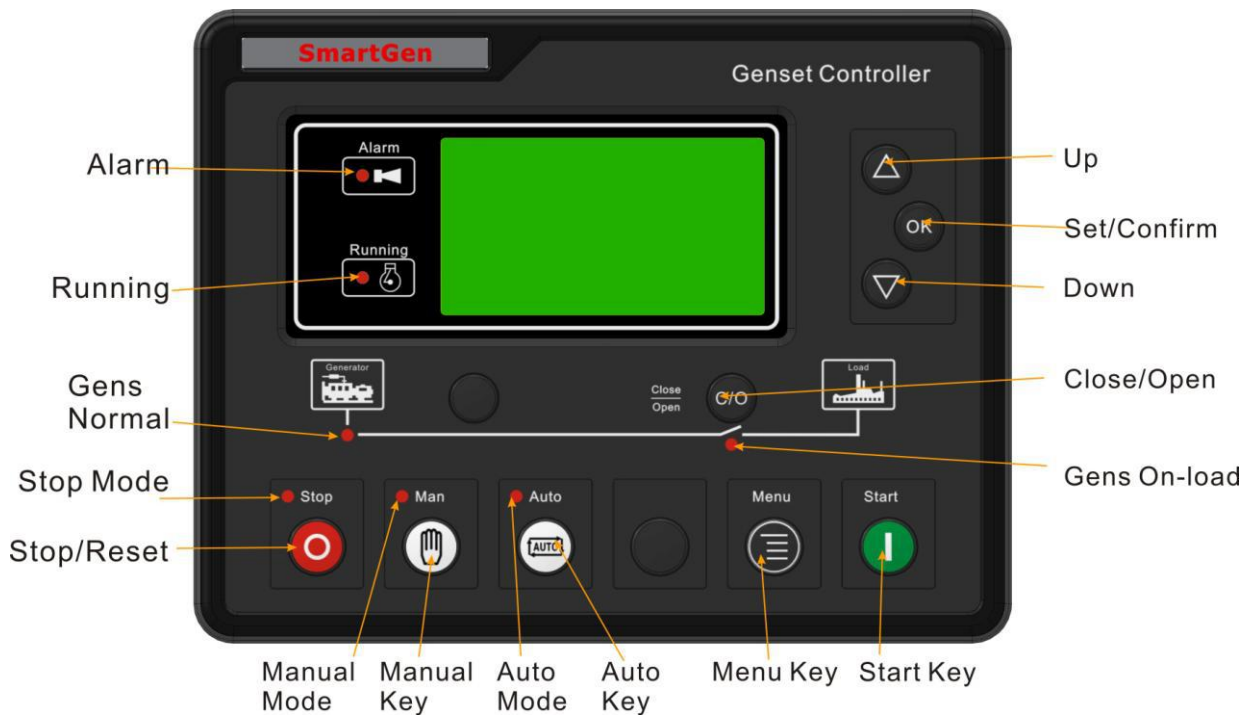

HGM6120UC Panel Indicators

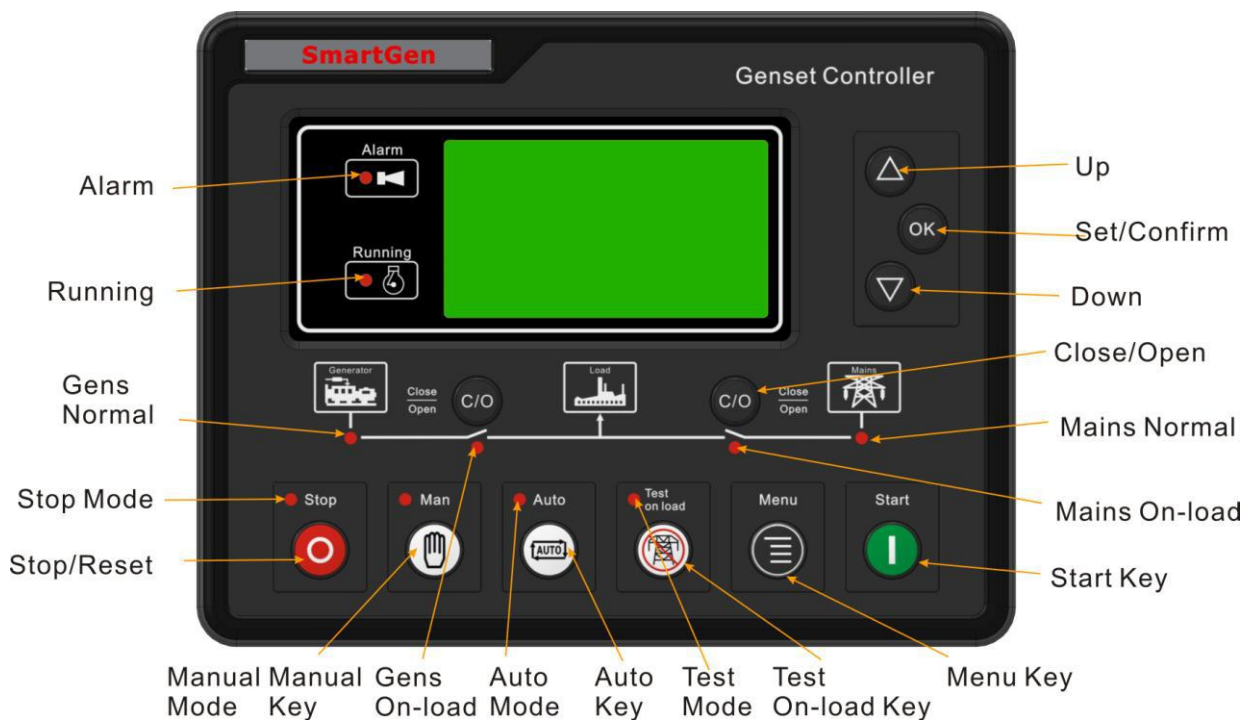

4.3 AUTOMATIC START/STOP OPERATION

Auto mode is activated by pressing the  , LED indicator beside the button is illuminating which confirms this action.

Starting Sequence,









- 1) **HGM6120UC:** When mains is abnormal (over/under voltage, lack of phase), enter into “Mains Abnormal Delay” and LCD displays count-down time. When delay is over, “Start Delay” begins.
- 2) **HGM6110UC:** when “remote start” input is active, enter into “Start Delay”.
- 3) “Count- down” of start delay is displayed in LCD.
- 4) When start delay is over, preheat relay is outputting (if configured), “Preheat Delay XX s” is displayed in LCD.
- 5) When preheat delay is over, fuel relay is outputting for 1s and then start relay outputs; if genset failed to start during “Crank Time”, the fuel and start relay stop outputting and enter into “Crank Rest Time” and wait for next cranking.
- 6) If genset failed to start within set start times, the fourth line of LED will turn black and Fail to Start alarm will be displayed.
- 7) Any time to start genset successfully, it will enter into “Safe Running”. During this period, alarms of low oil pressure, high temperature, under speed, charge failure and Aux. input (be configured) are disabled. As soon as this delay is over, genset will enter into “Start Idle Delay” (if configured).
- 8) During start idle delay, alarms of under speed, under frequency, under voltage are disabled. As soon as this delay is over, genset will enter into “Warming up Delay” (if configured).
- 9) When “Warming up Delay” is over, the indicator is illuminating if gens normal. If voltage and frequency of engine reach the load requirement, close relay outputs, genset is taking load and indicator illuminates; if engine voltage or frequency is abnormal, controller will alarm and shutdown (LCD displays the alarm information).

Stopping Sequence,

- 1) **HGM6120UC:** during normal running, if mains normal, genset will enter into “Mains Normal Delay”, when mains indicator illuminates, “Stop Delay” begins.
- 2) **HGM6110UC:** genset enters into “Stop Delay” as soon as “Remote Start” is inactive.

- 3) When “Stop Delay” is over, genset enters into “Cooling Delay”. Closing relay is disconnected. After switch “Transfer Rest Delay”, closing relay is outputting, mains is taking load, generator indicator eliminates while mains indicator illuminates.
- 4) When entering “Stop Idle Delay”, idle relay is energized to output. (If configured).
- 5) When entering “ETS Delay”, ETS relay is energized to output, fuel relay output is disconnected.
- 6) When entering “Genset at Rest”, genset will automatically judge if it has stopped.
- 7) When genset has stopped, enter into standby mode; if genset failed to stop, controller will alarm (“Fail to Stop” alarm will be displayed in LCD).

4.4 MANUAL START/STOP OPERATION

- 1) **HGM6120UC**, Auto Mode is active when press  and its indicator illuminates. Press , then controller enters into “Manual Test Mode” and its indicator is illuminating. Under both of the modes, press  to start genset, it can automatically detect crank disconnect and accelerate to high speed running. If there is high temperature, low oil pressure, over speed and abnormal voltage during genset running, controller can protect genset to stop (detail procedures please refer to No.4~9 of Auto start operation). Under Manual Mode, switch won't transfer automatically, it is necessary to press  to transfer load. Under “Manual Test Mode”, after genset runs well in high speed, no matter mains is normal or not, loading switch will be transferred to gens.
- 2) **HGM6110UC**, Auto Mode is active when pressing , and its indicator is illuminating. Then press  to start genset, it can automatically detect crank disconnect and accelerate to high speed running. If there is high temperature, low oil pressure, over speed and abnormal voltage during running, controller can protect genset to stop quickly (detail procedures please refer to No.4~9 of Auto start operation). After genset runs well in high speed, press  and gens take load.
- 3) Manual stop, pressing  can shut down the running genset (detail procedures please refer to No.3~7 of Auto stop operation).

5 PROTECTION

5.1 WARNINGS

When controller detects the warning signal, the genset only alarm and not stop. The alarms are displayed in LCD.

Warnings as following,

No.	Items	Description
1	Loss Of Speed Signal	When the speed of genset is 0 and speed loss delay is 0, controller will send warning alarm signal and it will be displayed in LCD.
2	Genset Over Current	When the current of genset is higher than threshold and setting over current delay is 0, controller will send warning alarm signal and it will be displayed in LCD.
3	Fail To Stop	When genset cannot stop after the “stop delay” is over, controller will send warning alarm signal and it will be displayed in LCD.
4	Low Fuel Level	When the fuel level of genset is lower than threshold or low fuel level warning is active, controller will send warning alarm signal and it will be displayed in LCD.
5	Charge Failure	When the voltage of genset charger is lower than threshold, controller will send warning alarm signal and it will be displayed in LCD.
6	Battery Under Voltage	When the battery voltage of genset is lower than threshold, controller will send warning alarm signal and it will be displayed in LCD.
7	Battery Over Voltage	When the battery voltage of genset is higher than threshold, controller will send warning alarm signal and it will be displayed in LCD.
8	Low Water Level	When low water level input is active, controller will send warning alarm signal and it will be displayed in LCD.
9	Temp. Sensor Open Circuit	When sensor hasn't connected to corresponding port, controller will send warning alarm signal and it will be displayed in LCD.
10	Oil Pressure Sensor Open Circuit	When sensor hasn't connected to corresponding port, controller will send warning alarm signal and it will be displayed in LCD.
11	Maintenance time out warn	When genset running time is longer than maintenance time of user setting, and the maintenance action is set as warning, controller send warning alarm signal and it will be

HGM6100U Series Automatic Control Module

No.	Items	Description
		displayed in LCD. When maintenance action type is set as "Not used", maintenance alarm reset.

5.2 SHUTDOWN ALARMS

When controller detects shutdown alarm, it will send signal to open switch and stop genset. The alarms are displayed in LCD.

Shutdown alarms as following,

No.	Items	Description
1	Emergency Stop	When controller detects emergency stop signal, it will send a stop alarm signal and it will be displayed in LCD.
2	High Temp. Shutdown	When the temperature of water/cylinder is higher than set threshold, controller will send a stop alarm signal and it will be displayed in LCD.
3	Low Oil Pressure Shutdown	When oil pressure is lower than threshold, controller will send a stop alarm signal and it will be displayed in LCD.
4	Over Speed Shutdown	When genset speed is higher than set threshold, controller will send a stop alarm signal and it will be displayed in LCD.
5	Under Speed Shutdown	When genset speed is lower than set threshold, controller will send a stop alarm signal and it will be displayed in LCD.
6	Loss Of Speed Signal Shutdown	When rotate speed is 0 and delay is not 0, controller will send a stop alarm signal and it will be displayed in LCD.
7	Genset Over Voltage Shutdown	When genset voltage is higher than threshold, controller will send a stop alarm signal and it will be displayed in LCD.
8	Genset Under Voltage Shutdown	When genset voltage is under set threshold, controller will send a stop alarm signal and it will be displayed in LCD.
9	Genset Over Current Shutdown	When genset current is higher than set threshold and delay is not 0, it will send a stop alarm signal and it will be displayed in LCD.
10	Fail To Start	Within set start times, if failed to start, controller will send a stop alarm signal and it will be displayed in LCD.
11	Over Frequency Shutdown	When genset frequency is higher than set threshold, controller will send a stop alarm signal and it will be displayed in LCD.
12	Under Frequency Shutdown	When genset frequency is lower than set threshold, controller will send a stop alarm signal and it will be displayed in LCD.
13	Genset Failed	When genset frequency is 0, controller will send a stop alarm signal and it will be displayed in LCD.
14	Low Fuel Level	When fuel level low input is active, controller will send a stop alarm signal and it will be displayed in LCD.
15	Low Water Level	When genset water level low input is active, controller will send a stop alarm signal and it will be displayed in LCD.

No.	Items	Description
16	Temp. Sensor Open Circuit	When sensor hasn't connected to corresponding port, controller will send shutdown alarm signal and it will be displayed in LCD.
17	Oil Pressure Sensor Open Circuit	When sensor hasn't connected to corresponding port, controller will send shutdown alarm signal and it will be displayed in LCD.
18	Maintenance time out shutdown	When genset running is longer than maintenance time of user setting, and maintenance action is set as shutdown, controller send shutdown alarm signal and it will be displayed in LCD. When maintenance action type is set as "Not used", maintenance alarm reset.

6 CONNECTIONS

Compared with HGM6120UC, HGM6110UC doesn't have 3-phase input terminal of mains voltage. The back panel of HGM6110UC and HGM6120UC is as below.

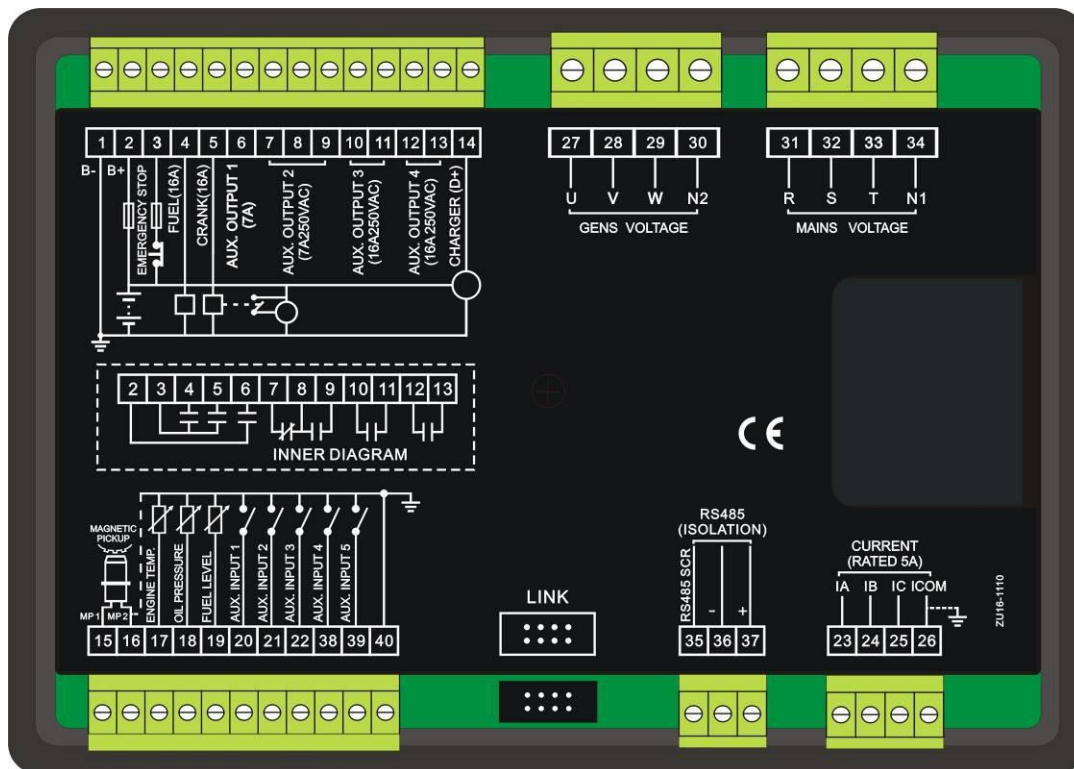

Descriptions of terminal connection as following,

No.	Function	Cable Size	Description
1	DC input B-	2.5mm ²	Connected to negative of starter battery
2	DC input B+	2.5mm ²	Connected to positive of starter battery. If wire length is over 30m, better to double wires in parallel. Max. 20A fuse is recommended.
3	Emergency Stop	2.5mm ²	Connected to B+ via emergency stop button.
4	Fuel Relay Output	1.5mm ²	B+ is supplied by 3 points, rated 16A
5	Start Relay Output	1.5mm ²	B+ is supplied by 3 points, rated 16A Connect to starter coil
6	Aux. Relay Output 1	1.5mm ²	B+ is supplied by 2 points, rated 7A
7	Aux. Relay Output 2	1.5mm ²	Normal close output, 7 A rated.
8			Relay common port
9			Normal open output, 7 A rated.
10	Aux. Relay Output 3	2.5mm ²	Relay normal open

HGM6100U Series Automatic Control Module

No.	Function	Cable Size	Description	
11			volt-free contact output 16 A rated	
12	Aux. Relay Output 4	2.5mm ²		
13				
14	Charging Generator D+ Input	1.0mm ²	Connect to D+ (WL) terminal. If without, the terminal is not connected.	
15	Speed sensor input	0.5mm ²	Connected to Speed sensor, shielding line is recommended.	
16	Speed sensor input, B- is connected.			
17	Temp. Sensor Input	1.0mm ²	Connect to water /cylinder temp. resistance type sensor	Reference table 4
18	Oil Pressure Sensor Input	1.0mm ²	Connect to oil pressure resistance type sensor	
19	Liquid Level Sensor Input	1.0mm ²	Connect to liquid level resistance type sensor	
20	Configurable Input 1	1.0mm ²	Ground connected is active (B-)	Reference table 3
21	Configurable Input 2	1.0mm ²	Ground connected is active (B-)	
22	Configurable Input 3	1.0mm ²	Ground connected is active (B-)	
23	CT A Phase Sensing Input	1.5mm ²	Connect secondary coil, rated 5A	
24	CT B Phase Sensing Input	1.5mm ²	Connect secondary coil, rated 5A	
25	CT C Phase Sensing Input	1.5mm ²	Connect secondary coil, rated 5A	
26	CT Common Port	1.5mm ²	Refer to INSTALLATION description.	
27	Generator U phase Voltage Sensing Input	1.0mm ²	Connect to U phase output(2A fuse is recommended)	
28	Generator V phase Voltage sensing Input	1.0mm ²	Connect to V phase output(2A fuse is recommended)	
29	Generator W phase Voltage Sensing Input	1.0mm ²	Connect to W phase output(2A fuse is recommended)	
30	Generator N2 Input	1.0mm ²	Connect to generator N-wire	
31	Mains R phase Voltage Sensing Input	1.0mm ²	Connect to mains R phase(2A fuse is recommended) HGM6110UC without	
32	Mains S phase Voltage Sensing Input	1.0mm ²	Connect to mains S phase (2A fuse is recommended) HGM6110UC without.	
33	Mains T phase Voltage Sensing Input	1.0mm ²	Connect to mains T phase, (2A fuse is recommended) HGM6110UC without.	

No.	Function	Cable Size	Description	
34	Mains N1 Input	1.0mm ²	Connect to mains N-wire, HGM6110UC without.	
35	RS485 Common Ground	/	Impedance-120Ω shielding wire is recommended, its single-end connect with ground.	
36	RS485 -	0.5mm ²		
37	RS485+	0.5mm ²		
38	Configurable Input 4	1.0mm ²	Ground connected is active (B-)	Reference table 3
39	Configurable Input 5	1.0mm ²	Ground connected is active (B-)	
40	Sensor Common	1.0mm ²	Sensor common port	

 **Note:** LINK ports in controller rear panel are programmable parameter ports, user can directly program SG72 via PC.

7 PARAMETER RANGE AND DEFINITION

7.1 PARAMETER CONTENT AND RANGE TABLE (TABLE 1)

No.	Items	Range	Default	Description
1	Mains Normal Delay	(0-3600)s	10	The delay from abnormal to normal or from normal to abnormal. It used for ATS (automatic transfer switch) control.
2	Mains Abnormal Delay	(0-3600)s	5	
3	Mains Under Voltage	(30-620)V	184	When mains voltage is under the point, mains under voltage active. When the value is 30, mains under voltage disabled.
4	Mains Over Voltage	(30-620)V	276	When mains voltage is greater than the point, mains over voltage active. When the point is 620V, mains over voltage disabled.
5	Transfer Rest Time	(0-99.9)s	1.0	It's the delay from mains open to generator closed or from generator open to mains closed.
6	Start Delay	(0-3600)s	1	Time from mains abnormal or remote start signal is active to start genset.
7	Stop Delay	(0-3600)s	1	Time from mains normal or remote start signal is inactive to genset stop.
8	Start Times	(1-10) times	3	When engine start failure, it's the maximum cranking times. When setting crank times out, controller send start fail signal.
9	Preheat Time	(0-300)s	0	Time of pre-powering heat plug before starter is powered up.
10	Crank Time	(3-60)s	8	Time of starter power up each time.
11	Crank Rest Time	(3-60)s	10	The second waiting time before power up when engine start fail.
12	Safe Running Time	(1-60)s	10	Alarm for low oil pressure, high temp, under speed, under frequency /voltage, charge fail are all inactive.

HGM6100U Series Automatic Control Module

No.	Items	Range	Default	Description
13	Start Idle Time	(0-3600)s	0	Idle running time of genset when starting.
14	Warming Up Time	(0-3600)s	10	Warming time between genset switch on and high speed running.
15	Coolant Time	(3-3600)s	10	Time for cooling before stopping.
16	Stop Idle Time	(0-3600)s	0	Idle running time when genset stop.
17	ETS Time	(0-120)s	20	Stop electromagnet's power on time when genset is stopping.
18	Over Stop Delay	(0-120)s	0	If "ETS output time" set as 0, it is the time from end of idle delay to gen-set at rest; if not 0, it is from end of ETS solenoid delay to gen-set at rest
19	Switch Close Delay	(0-10)s	5.0	Mains' or generator's switch closing pulse width, when it is 0, output is continuous.
20	Flywheel Teeth	(10-300)	118	Number of flywheel teeth, it can detect disconnection conditions and engine speed.
21	Genset Abnormal Delay	(0-20.0)s	10.0	Over or under volt alarm delay
22	Genset Over Voltage shutdown	(30-620)V	264	When genset voltage is over the point, generator over voltage is active. When the point is 620V, generator over voltage is disabled.
23	Genset Under Voltage	(30-620)V	196	When generator voltage is under the point, generator under voltage is active. When the point is 30V, generator under voltage is disabled.
24	Under Speed shutdown	(0-6000)RPM	1200	When the engine speed is under the point for 10s, shutdown alarm signal is sent out.
25	Over Speed shutdown	(0-6000)RPM	1710	When the engine speed is over the point for 2s, shutdown alarm signal is sent.

HGM6100U Series Automatic Control Module

No.	Items	Range	Default	Description
26	Under Frequency shutdown	(0-75.0)Hz	45.0	When generator frequency is lower than the point (not equal to 0) for 10s, shutdown alarm signal is sent.
27	Over Frequency shutdown	(0-75.0)Hz	57.0	When generator's frequency is over the point and continues for 2s, generator over frequency is active.
28	High Temperature shutdown	(80-140)°C	98	When engine temperature sensor value is over this point, it sends out high temp. alarm. When the value is 140, warning alarm won't be sent. (only suited for temperature sensor, except for high temp. pressure alarm signal inputted by programmable input port)
29	Low Oil Pressure shutdown	(0-400)kPa	103	When engine oil pressure sensor value is under this point, Low Oil Pressure alarm is sending out. When the value is 0, warning alarm won't be sent. (only suited for oil pressure sensor, except for low oil pressure alarm signal inputted by programmable input port)
30	Low Fuel Level	(0-100)%	10	When fuel level sensor value under this point and remains for 10s, genset send out warning alarm, only warn but not shutdown.
31	Loss Of Speed Signal Delay	(0-20.0)s	5.0	When the delay setting as 0s, it only warn but not shutdown
32	Charge Failure	(0-30)V	6.0	During generator is running, when charge alternator WL/D+ voltage is under this point and remain for 5s, generator will warning alarm and shutdown.
33	Battery Voltage Over	(12-40)V	33.0	When generator battery voltage is over the point and remains for 20s, battery over voltage signal is active. it only warn but not shutdown

HGM6100U Series Automatic Control Module

No.	Items	Range	Default	Description
34	Battery Under Voltage	(4-30)V	8.0	When generator battery voltage is under the point and remains for 20s, battery under voltage signal is active. it only warn but not shutdown
35	CT Rate	(5-6000)/5	500	Current transformer rate
36	Full Load Current	(5-6000)A	500	Rated current of generator, used for calculating over load current.
37	Over Current Percentage	(50-130)%	120	When load current is over the point, the over current delay is initiated.
38	Over Current Delay	(0-3600)s	1296	When load current is over the point, over current signal is sent. When the delay is 0, only warn but not shutdown.
39	Fuel Pump Open	(0-100)%	25	When the fuel level lower than the set value for 10s, send a signal to open fuel pump.
40	Fuel Pump Close	(0-100)%	80	When the fuel level higher than the set value for 10s, send a signal to close fuel pump.
41	Aux. Output 1	(0-17)	2	Factory default: Energized to stop
42	Aux. Output 2	(0-17)	3	Factory default: Idle control
43	Aux. Output 3	(0-17)	5	Factory default: Gens closed
44	Aux. Output 4	(0-17)	6	Factory default: Mains closed
45	Aux. Input 1	(0-15)	1	Factory default: High temperature alarm
46	Aux. Input 1 Active	(0-1)	0	Factory default: close
47	Aux. Input 1 Delay	(0-20.0)s	2.0	
48	Aux. Input 2	(0-15)	2	Factory default: Low oil pressure alarm
49	Aux. Input 2 Active	(0-1)	0	Factory default: close
50	Aux. Input 2 Delay	(0-20.0)s	2.0	
51	Aux. Input 3	(0-15)	10	Factory default: Remote start input
52	Aux. Input 3 Active	(0-1)	0	Factory default: close

HGM6100U Series Automatic Control Module

No.	Items	Range	Default	Description
53	Aux. Input Delay 3	(0-20.0)s	2.0	
54	Aux. Input 4	(0-15)	11	Factory default: Low fuel level warn
55	Aux. Input Active 4	(0-1)	0	Factory default: close
56	Aux. Input Delay 4	(0-20.0)s	2.0	
57	Aux. Input 5	(0-15)	12	Factory default: Low coolant level warn
58	Aux. Input Active 5	(0-1)	0	Factory default: close
59	Aux. Input Delay 5	(0-20.0)s	2.0	
60	Power Mode Select	(0-2)	0	0: Stop Mode; 1: Manual Mode; 2: Auto Mode
61	Module Address	(1-254)	1	The address of controller.
62	Password	(0-9999)	1234	
63	Crank Disconnect Condition	(0-5)	2	Conditions of disconnecting starter (generator, magnetic pickup sensor, oil pressure), Each condition can be used alone and simultaneously to separating the start motor and genset as soon as possible.
64	Engine Speed	(0-3000)RPM	360	When engine speed is over this point, starter will disconnect.
65	Engine Frequency	(10-30)Hz	14	When generator frequency is over this point, starter will disconnect.
66	Engine Oil Pressure	(0-400)kPa	200	When engine oil pressure is over this point, starter will disconnect.
67	High Temp. Inhibit Select	(0-1)	0	Default: when temperature is overheat, the genset alarm and shutdown. Note1
68	Low OP Inhibit Select	(0-1)	0	Default: when oil pressure is too low, it alarm and shutdown. Note2
69	Voltage Input Select	(0-3)	0	0: 3P4W 1: 2P3W 2: 1P2W 3: 3P3W
70	Temp. Sensor Select	(0-9)	8	SGX

No.	Items	Range	Default	Description
71	Pressure Sensor Select	(0-9)	8	SGX
72	Liquid Level Sensor Select	(0-5)	3	SGD
73	Poles Number	(2-32)	4	Number of magnetic poles, used for calculating rotating speed of generator without speed sensor.
74	Temp. Sensor Open Circuit Action	(0-2)	1	0: Indication; 1: Warning; 2: Shutdown
75	Oil Pressure Sensor Open Circuit Action	(0-2)	1	
76	Maintenance time	(0-5000)h	30	It is used for setting genset maintenance interval.
77	Maintenance time out action	(0-2)	0	0 Not used; 1 Warning; 2 Shutdown When maintenance action type is set as “Not used” maintenance alarm reset.
78	Defined Sensor Curve	(0-2)		0:Defined temperature sensor 1: Defined pressure sensor 2: Defined liquid level sensor Select the sensor, input corresponding 8 values.

Note1, if select high temperature inhibit, or set programmable input as High Temperature Inhibit (this input is active), when temperature is higher than pre-setting threshold or high temperature alarm is activated, controller sends warning signal only and not shutdown.

Note2, if select low oil pressure inhibit, or set programmable input as Low Oil Pressure Inhibit (this input is active), when low oil pressure is lower than pre-setting threshold or low oil pressure alarm is activated, controller sends warning signal only and not shutdown.

7.2 PROGRAMMABLE OUTPUT 1-4 TABLE (TABLE 2)

No.	Items	Description
0	Not Used	Output is disabled when this item is selected.
1	Common Alarm	Including all shutdown alarm and warning alarm. When a warning alarm occurs, the alarm won't self-lock; When a shutdown alarm occurs, the alarm will self-lock until alarm is reset.
2	ETS Control	Used for the genset with stop solenoid. Pick-up when idle speed is over while disconnect when ETS delay is over.
3	Idle Control	Used for the genset with idle speed. Pick-up when crank while disconnect when enter into warming up. Pick-up when stop idle while disconnect when genset stop completely.
4	Preheat Control	Close before started and disconnect before powered on.
5	Gens Close	When close time is set as 0, it is continuous closing.
6	Mains Close	HGM6110UC without.
7	Open Breaker	When close time is set as 0, Open Breaker is disabled.
8	Accelerate Control	Pick-up when enter into warming up time. Disconnect when raise speed auxiliary input active.
9	Decelerate Control	Pick-up when enter into stop idle or ETS solenoid stop (shutdown alarm). Disconnect when droop speed auxiliary input active.
10	Genset Run Output	Output when genset is in normal running, disconnect when rotating speed is lower than engine speed after fired.
11	Fuel Pump Control	Pick-up when the fuel level lower than the open threshold or low fuel level warning is active; disconnect when the fuel level over the close threshold and the low fuel level warning input is disabled.
12	High Speed Control	Output when it enter into warming up time, and disconnect after cooling.
13	System In Auto Mode	The controller is in Auto Mode.
14	Reserved	
15	Reserved	
16	Reserved	
17	Reserved	

7.3 PROGRAMMABLE INPUT 1-5 TABLE (ALL IS ACTIVE WHEN CONNECT TO GROUND (B-) (TABLE 3))

No.	Items	Description
0	Not Used	
1	High Temp. Alarm	If the signal is active after safety run on delay over, genset will immediately alarm to shutdown.
2	Low OP Alarm	
3	Auxiliary Alarm	Only warn, not shutdown.
4	Aux. Shutdown Alarm	If the signal is active, genset will immediately alarm to shutdown.
5	Coolant To Stop	During engine running and the input is active, if high temperature occurs, controller will stop after high speed cooling; when the input is disabled, controller will stop immediately.
6	Gens Closed Input	
7	Mains Closed Input	
8	High Temp. Inhibit	When it is active, high oil temperature stop is inhibited. See Note1 for more information.
9	Low Oil Pressure Inhibit	When it is active, low oil pressure stop is inhibited. See Note2 for more information.
10	Remote Start Input	
11	Low Fuel Level Warn	
12	Low Water Level Warn	
13	Low Fuel Level Shutdown	
14	Low Water Level Shutdown	
15	Auto Start Inhibit	In Auto Mode, when the input is active, no matter mains normal or not, genset won't start. If genset is in normal running, stop process won't be executed. When input is disabled, genset will automatically start or stop judging by mains normal or not.

7.4 SENSOR SELECTION (TABLE 4)

No.	Items	Content	Description
1	Temperature Sensor	0 Not used 1 Defined Resistance Type 2 VDO 3 SGH(Huanghe sensor) 4SGD(DongKang sensor) 5 CURTIS 6 DATCON 7 VOLVO-EC 8 SGX 9 Reserved	Defined input resistance range is 0Ω~6000Ω, factory default is SGX sensor.
2	Pressure Sensor	0 Not used 1 Defined Resistance Type 2 VDO 10Bar 3 SGH(Huanghe sensor) 4 SGD(DongKang sensor) 5 CURTIS 6 DATCON 10Bar 7 VOLVO-EC 8 SGX 9 Reserved	Defined input resistance range is 0Ω~6000Ω, factory default is SGX sensor.
3	Fuel Level Sensor	0 Not used 1 Defined Resistance Type 2 SGH 3 SGD 4 Reserved 1 5 Reserved 2	Defined input resistance range is 0~6000Ω, factory default is SGD sensor.

7.5 CONDITIONS OF CRANK DISCONNECT (TABLE 5)

No.	Content
0	Magnetic pickup sensor
1	Generator
2	Magnetic pickup sensor + Generator
3	Magnetic pickup sensor + Oil pressure
4	Generator + Oil pressure
5	Generator + Magnetic pickup sensor + Oil pressure

- 1) There are 3 kinds of crank disconnect conditions. Magnetic pickup sensor and generator can be used alone. Oil pressure must be used with magnetic pickup sensor and the generator, in order to make the starter and the engine disconnect as soon as possible.
- 2) Magnetic pickup sensor is installed in the engine for testing flywheel teeth.
- 3) When choosing magnetic pickup sensor, ensure the number of flywheel teeth is same as the pre-set, otherwise over or under speed shutdown may appear.
- 4) If generator has no magnetic pickup sensor, don't choose corresponding item; otherwise Fail to Start or Loss of Speed Signal shutdown will occur.
- 5) If the generator has no oil pressure sensor, don't choose corresponding item.
- 6) If generator has not been selected, controller will not measure and display the relative parameters (can be applied to the pump set); if magnetic pickup sensor has not been selected, the rotating speed will be calculated by the generating AC signal.

8 PARAMETER SETTING

After controller powered on, press  to enter into the parameters setting menu:

- 1) Parameters Setting
- 2) Information
- 3) Language

1) Parameters Setting

"1234" can set the part of the items in Table 1 during inputting password,; "0318" can set all items in Table 1.



If more parameter items need to be set, such as voltage and current calibration, please contact with the factory.

NOTE:

- 1) **HGM6110UC**, there are not items 1-5 in table1; programmable output 1-4 have no digital outputs about mains.
- 2) Please modify the parameters in standby mode (crank conditions, auxiliary input and output configuration, multi delays, etc.) otherwise shutdown alarm or other abnormal conditions may appear.
- 3) The over-voltage threshold must be greater than the under-voltage threshold; otherwise over-voltage and under-voltage will occur at the same time.
- 4) The over-speed threshold must be greater than under-speed threshold, otherwise over speed and under speed will occur at the same time.
- 5) Set frequency value (after crank disconnect) as low as possible, in order to disconnect starter quickly.
- 6) Programmable input 1-5 cannot be set as the same items, otherwise it cannot realize correct function; programmable output 1-4 can be set as the same item.
- 7) If need to shut down after cooling, please set any input as " stop after cooling ", then connect this input to ground.

2) Information

LCD will display some information of controller, such as software version, issue date.



 **Note:** Pressing  will display the status of digital inputs and outputs.

3) Language

User may select display language as Chinese, English, Spanish and Russian.

4) LCD contract

Press  and  (or ) can adjust LCD contract. Adjustment range is 0-7.

 **Note:** Pressing  key at any time will exit the editor and back to main interface.

9 SENSOR SETTING

- 1) When choosing sensor, standard of sensor curve will be needed. If temperature sensor is set as SGH (120°C resistor type), sensor curve should be SGH (120°C resistor type); If it is set as SGD (120°C resistor type), sensor curve should be SGD curve.
- 2) If there is difference between standard sensor curve and chosen sensor curve, select "defined sensor", and then input defined sensor curve.
- 3) When sensor curve is inputted, X value (resistance) must be in accordance with the order of higher to lower, otherwise errors will occur.
- 4) When sensor is selected as "Not used", temperature, pressure and fuel level will be display as " - - -" in LCD.
- 5) If there is no pressure sensor, but only has low pressure alarm switch, then you must set pressure sensor as "Not used", otherwise oil pressure low alarm shutdown may appear.
- 6) Can set several points of forehead or backmost as the same ordinate, as the following picture:

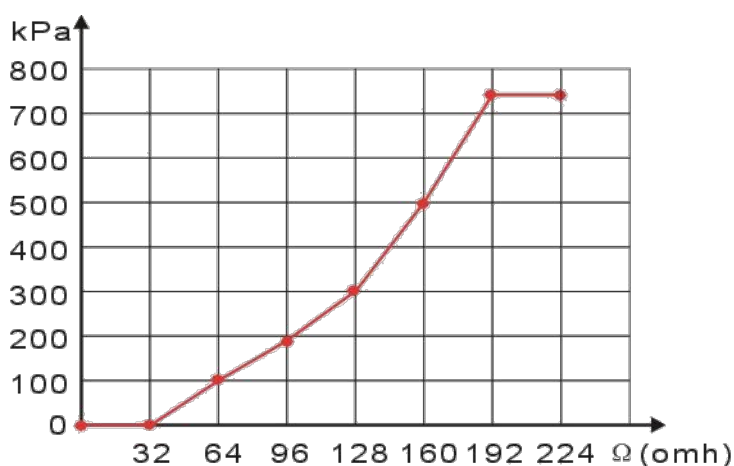

Conventional pressure unit conversion table

	1N/m ² (pa)	1kgf/cm ²	1bar	(1b/in ²) psi
1Pa	1	1.02x10 ⁻⁵	1x10 ⁻⁵	1.45x10 ⁻⁴
1kgf/cm ²	9.8x10 ⁴	1	0.98	14.2
1bar	1x10 ⁵	1.02	1	14.5
1psi	6.89x10 ³	7.03x10 ⁻²	6.89x10 ⁻²	1

10 COMMISSIONING

Before operation, the following checking should be carried out:

- 1) Check and ensure all the connections are correct and wires diameter is suitable.
- 2) Ensure that the controller DC power has fuse; battery positive and negative have correctly connected.
- 3) Emergence stop input must be connected to positive of starting battery via normally close contact of emergency stop.
- 4) Take proper actions to prevent engine to disconnect crank (e. g. Remove the connections of fuel valve). If checking is OK, connect start battery, select Manual Mode, controller will execute the program.
- 5) Set controller as Manual Mode, press “start” button to start genset. If failed within the setting crank times, controller will send “Failed to Start” signal; then press “stop” to reset controller.
- 6) Recover actions of preventing engine to disconnect crank (e. g. Connect wire of fuel valve), press “start” button again, genset will start. If everything goes well, genset will normal run after idle running (if configured). During this period, watch for engine’s running situations and voltage and frequency of alternator. If there is abnormal, stop genset and check all connections according to this manual.
- 7) Select the Auto Mode from front panel, connect to mains signal. After the mains normal delay, controller will transfer ATS (if configured) into mains load. After cooling, controller will stop genset and into standby state until mains abnormal again.
- 8) When mains abnormal again, genset will start automatically and into normal running, send signal to make gens close, transfer ATS and make genset take load. If it not likes this, please check connections of ATS according to this manual.
- 9) If there are any other questions, please contact Smartgen’s service.

11 TYPICAL APPLICATION

HGM6110UC Typical Application Diagram

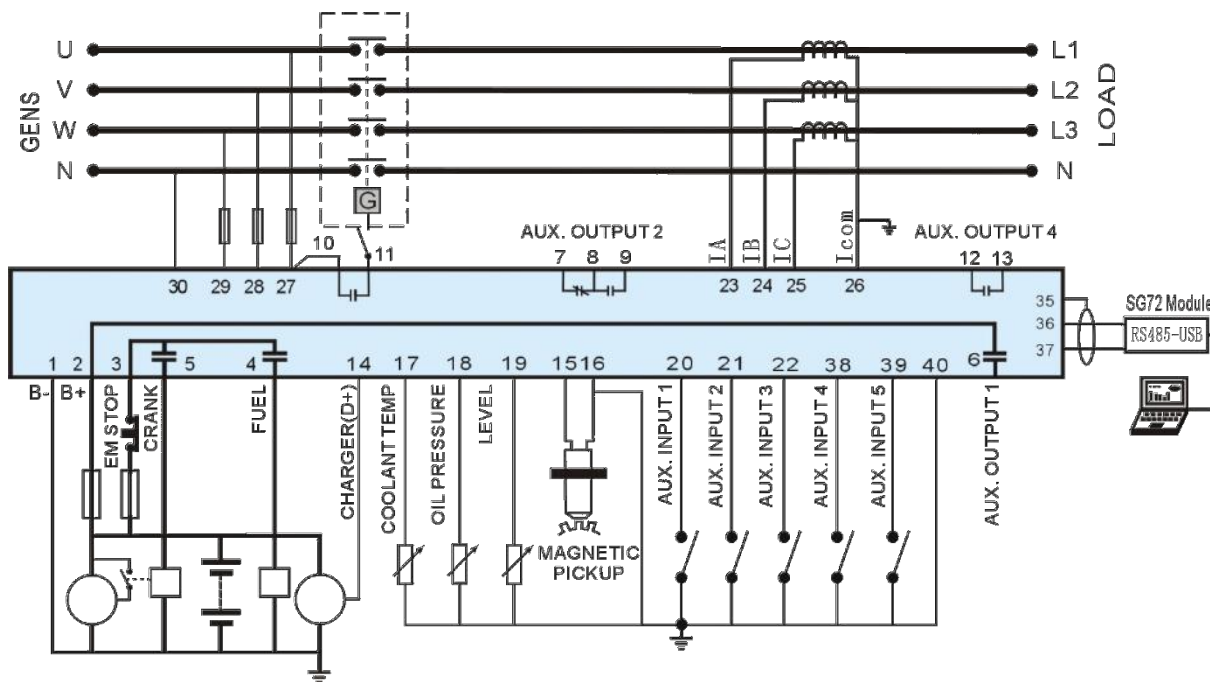

HGM6120UC Typical Application Diagram

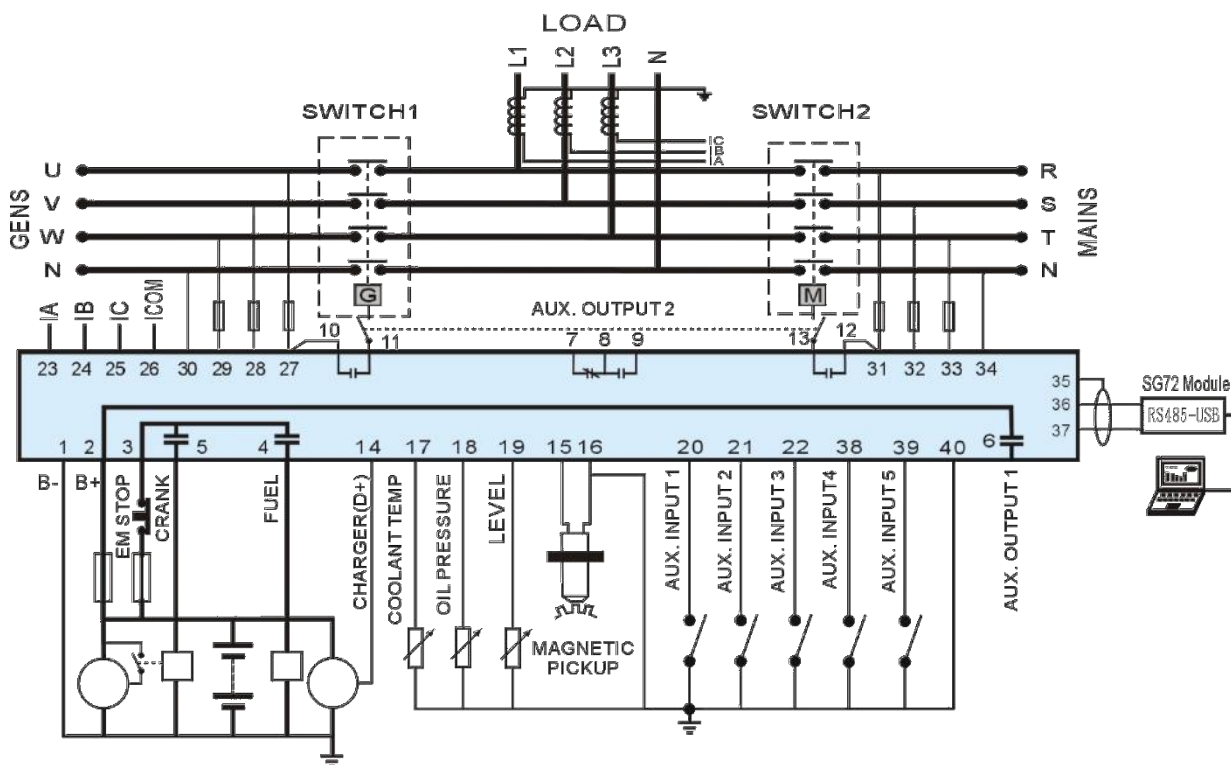

Single Phase 2 Wire

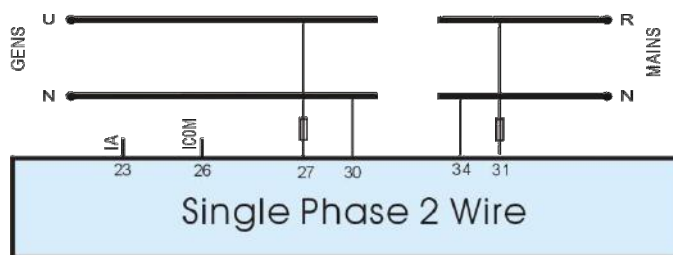

2 Phase 3 Wire

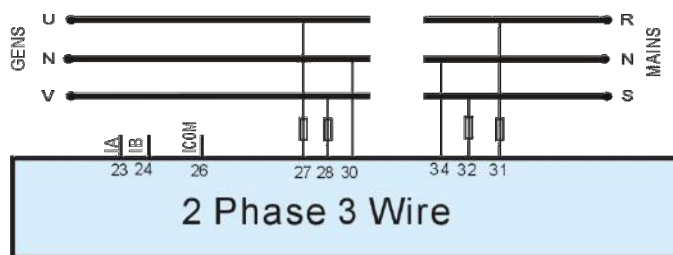

Note: Recommend that the output of crank and Fuel expand high capacity relay.

12 INSTALLATION

12.1 FIXING CLIPS

The module is held into the panel fascia using the supplied fixing clips.

- 1) Withdraw the fixing clip screw (turn anticlockwise) until it reaches proper position.
- 2) Pull the fixing clip backwards (towards the back of the module) ensuring four clips are inside their allotted slots.
- 3) Turn the fixing clip screws clockwise until they make contact with the panel.

Note: Care should be taken not to over tighten the screws of fixing clips.

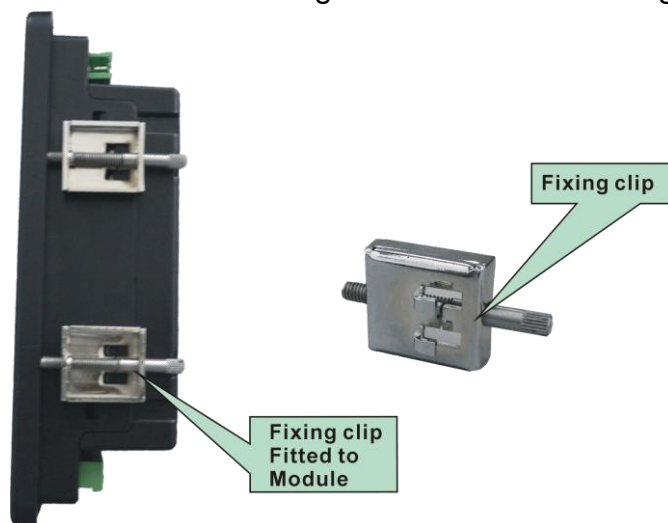

12.2 OVERALL DIMENSION AND PANEL CUTOUT

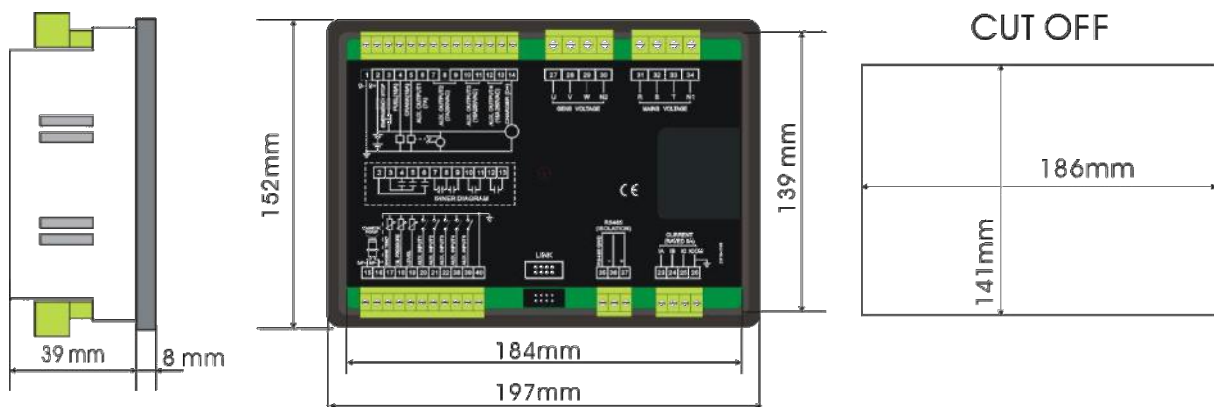

1) Battery Voltage Input

HGM6100U series controller can be applicable to (8~35) VDC battery voltage. Battery negative must be reliably connected to engine shell. The connection between controller power and battery should not be less than 2.5mm^2 . If a float charger is fitted, please connect output line of the charger with battery directly, and then connect battery positive and negative to power input of controller separately, in case that charger will interfere with the normal running of controller.

2) Speed Sensor Input

Speed sensor is installed in the engine for testing flywheel teeth. The connection with controller uses 2-core screen, shield layer should be connected to terminal16 of controller and the other end vacant. The other two signal lines are respectively connected to terminal15 and terminal16. At full speed, output voltage range is (1~24) VAC (RMS), 12VAC is recommended (rated speed). During installing, make the speed sensor contact the flywheel firstly, then pour out 1/3 laps, finally lock nut on the sensor.

3) Output And Expansion Relay

All the outputs of controller are relay output. If need to expand relay, please add freewheeling diode in both ends of relay coil (when expansion relay coil links DC), or add RC loop (when expansion relay coil links AC), in case controller or other equipments are interfered.

4) AC Input

HGM6100U series controller must externally connect to current transformer; CT secondary current must be 5A. Besides, the phase of CT and input voltage must be correct, or the sampling current and active power may be incorrect.

Note: A. ICOM must connect to battery cathode of the controller.

B. When there is load current, open circuit is inhibited in the CT secondary side.

5) Dielectric Strength test

When the controller has been installed in the control panel, during the test please disconnect all the terminals in case high voltage damages the controller.

13 FAULT FINDING

Symptoms	Possible Solutions
Controller Inoperative	Check starting battery; Check connections of controller. Check the DC fuse.
Genset Stops	Check if water/cylinder temperature too high. Check alternator voltage. Check the DC fuse.
Emergency Stop	Check if an emergency stop button is fitted; Ensure battery positive is connected to the emergency stop input. Check if connection is open circuit.
Low Oil Pressure Alarm (After Crank Disconnect)	Check oil pressure sensor and connections.
High Temp. Alarm (After Crank Disconnect)	Check temperature sensor and connections.
Shutdown Alarm During Running	Check switch and connections according to information on LCD. Check configurable inputs.
Crank Disconnect Failed	Check connections of fuel solenoid. Check starting battery. Check speed sensor and its connections. Refer to engine manual.
Starter Inoperative	Check connections of starter; Check starting battery.
Genset Running While ATS Not Transfer	Check ATS; Check connections between ATS and controller.
RS485 Failure	Check connections; Check if COM port is correct; Check if A and B of RS485 is connected reversely; Check if PC COM port is damaged; 120Ω resistance between PR485 and AB is Recommended.